

IVECO T-WAY
DRIVE THE NEW WAY



IVECO

Your partner for sustainable transport



IVECO T-WAY DRIVE THE NEW WAY

The IVECO T-WAY is the vehicle you want for the toughest missions in the most extreme conditions. With its perfect combination of robustness, reliability and comfort, it is designed to meet your requirements and exceed all your expectations on productivity, payload capacity, and safety.

With the legendary robustness of its chassis and components, it is built to perform extreme off-road missions. With a market-leading 40-tonne GVW. With the HI-TRACTION, advanced engineering and technological solutions, it can be relied on to deliver a consistently high performance in the most arduous off-road applications and hostile environments.

The IVECO T-WAY raises the driver's on-board experience to a new level with the new cab designed around their needs. It integrates the most advanced features of the new IVECO WAY range to provide an extremely comfortable and safe environment. Its advanced connectivity introduces a host of services developed to make the driver's life easier and maximise the vehicle's uptime.

The most reliable and productive heavy-duty truck in a construction environment, the IVECO T-WAY is truly unstoppable and equal to the toughest challenges.

| | | | |
|--|----|-------------------------------|----|
| ROBUSTNESS AND RELIABILITY | 04 | A WIDE VARIETY OF MISSIONS | 18 |
| NEW FUNCTIONAL DESIGN | 06 | CHOOSE YOUR CONFIGURATION | 22 |
| PREMIUM DRIVING COMFORT | 08 | IVECO ON | 24 |
| MOBILITY AND SAFETY ON ALL TERRAINS | 10 | ELEMENTS | 27 |
| HIGH VERSATILITY TO MATCH YOUR MISSION | 12 | IVECO ACCESSORIES | 28 |
| MIXER | 14 | IVECO SERVICES | 29 |
| TIPPER | 16 | CHOOSE YOUR IVECO T-WAY MODEL | 30 |

ROBUSTNESS AND RELIABILITY



The IVECO T-WAY has been engineered and built to guarantee reliability and durability in the toughest challenges and environments. The legendary robustness of the high resistance steel chassis with a 10mm thick frame, combined with the suspension system's high resistance, contribute to the excellent performance in the harshest conditions.

The new rear axles and the new-design air suspension for tandem axles have been tested in the harshest conditions. The redesign of a number of components contributes to a kerb weight optimisation up to 500kg, increasing the IVECO T-WAY's payload capacity.

NEW FUNCTIONAL DESIGN

The cab has been entirely redesigned focusing on functionality to facilitate the driver's daily work with features that improve visibility, protect from dirt, and much more. The new design also simplifies maintenance and repair operations, making it easier to change components. The chassis layout has been entirely reviewed to facilitate the customisation of bodybuilders.



IMPROVED SAFETY
FUNCTIONALITIES – LDWS, ESP & EBS

FRONT GRILLE DESIGN

OPTIMISED MIRROR DESIGN

CONSTANT REAR
FRAME SECTION

REAR AXLE HUB REDUCTION
WITH DISC BRAKES FOR PWD

HIGH CHASSIS ROBUSTNESS
WITH 10mm FRAME THICKNESS

MULTIPLE AXLE
CONFIGURATIONS

IMPROVED BRAKE PERFORMANCE
WITH NEW FRONT AXLES AND DISK BRAKES

COMPLETE PTO OFFERING

HI-TRONIX AUTOMATED
GEARBOX AVAILABLE

KERB WEIGHT OPTIMIZATION UP TO 500kg

CHOICE OF MECHANICAL AND PNEUMATIC SUSPENSIONS

MULTI-PIECE BUMPER

FULL LED HEADLIGHTS AND PROTECTION GRID

FOLDABLE STEP

PREMIUM DRIVING COMFORT

The entire driver's area has been created to provide the ultimate driving environment with outstanding ergonomics and controls layout, more space and excellent visibility. Every single detail has been carefully studied to meet the driver's expectations on the road.

INFOTAINMENT

Bring your digital life on board with smartphone mirroring and innovative features

TWILIGHT & RAIN SENSOR

Automatically turns on the headlights and windscreen wipers

INTEGRATED HVAC SYSTEM

Heating, ventilation and air conditioning with "Eco-mode" function

KEY LOCK AREA

Turn the engine on and off by simply pushing the Start/Stop button

STEERING WHEEL

All the vehicle's key functions at your fingertips



Dashboard AD-AT cab



Customise your seats with fabric upholstery or vinyl and with the red seat belts, and enjoy luxurious comfort of the cushions.



Choose the soft touch or leather steering wheel, both available in the classic shape or with the distinctive flat base.



Internal AD cab

MOBILITY AND SAFETY ON ALL TERRAINS

The IVECO T-WAY can rely on a vast range of features and functionalities to perform every type of mission flawlessly, delivering consistently high productivity on all terrains and conditions. It will complete your mission efficiently, ensuring the highest safety levels on- and off-road.

HI-TRONIX GEARBOX WITH OFF-ROAD FUNCTIONALITIES

With the 16-speed HI-TRONIX automated gearbox you can benefit from a host of functionalities such as Rocking Mode, Off-road Mode, Creeping Mode and 4 reverse gears to tackle with ease the toughest off-road conditions.

FULLY MODULAR SUSPENSION CONCEPT

The IVECO T-WAY offers ultimate flexibility with a choice of air and mechanical suspensions – both parabolic and semi-elliptic.

AWD & PWD

The IVECO T-WAY offers a complete line-up of AWD and PWD to meet the requirements of every mission – even the most demanding.

BRAKES PERFORMANCE AND SAFETY IMPROVEMENTS

The new architecture of the EBS system, combined with disc brakes on all wheels, has dramatically improved the vehicle's performance, and consequently the safety of the driver, vehicle and other road users.

HI-TRACTION - WHAT IT IS

The HI-TRACTION system is automatically activated to provide additional hydraulic front-wheel traction when needed to overcome the skidding of the rear axle on slippery surfaces. It delivers all the grip, manoeuvrability and driving safety advantages of all-wheel drive.

HI-TRACTION - HOW IT WORKS

1. The HI-TRACTION system can be activated manually with a button in the cab, switching from "inactive" to "ready to engage" mode.
2. The system is running in the background, ready to activate when needed.
3. When needed, the system automatically switches to "active" mode and provides front-wheel traction if the rear axle slips.
4. The system is turned off when:
 - The driver pushes the button in the cab.
 - The vehicle returns to normal driving and speed conditions.
 - Oil temperature in the hydraulic circuit exceeds 90°C.

The "boost" mode is activated at every standing start (0 to 3kph) to improve traction and reduce wear and tear of the clutch.



**UP TO 12,500Nm TORQUE AVAILABLE ON THE FRONT AXLE.
WITH BOOST MODE YOU HAVE ALL THE TRACTION
YOU NEED EVEN ON A STANDING START.**

FRONT AXLE MAX. TORQUE

up to
12,500Nm

SYSTEM WEIGHT

approx.
400kg

ACTIVATION RANGE

0-45kph

GEAR CHANGE

AUTOMATED

POWER TAKE-OFF

ENGINE PTO

HIGH VERSATILITY TO MATCH YOUR MISSION

The IVECO T-WAY is a highly versatile vehicle: with its legendary robustness, high payload capacity, kerb weight optimisation, and wide offering of features and components, it can be tailored to precisely match the requirements of your mission.



MISSION

| | |
|-----------------------------------|--------------|
| MIXER | 14-15 |
| TIPPER | 16-17 |
| A WIDE VARIETY OF MISSIONS | 18-19 |

MIXER

The IVECO T-WAY is built to carry massive payloads on all terrains – it can mount concrete mixers of high capacity up to 12m³ for a 32-tonne GVW.

IMPROVED DIRECT AND INDIRECT VISIBILITY

The aerodynamic design of the mirrors and their optimised positioning further improves visibility. The rear window of the AD/AT cabs provides excellent visibility on the rear of the vehicle.

NEW ESP AND LDWS

Functionalities for safety improvement.

POWERFULLY EFFICIENT ENGINES

The 13-litre engine delivers all the power you need with outstanding fuel efficiency.

IDEAL POWER TAKE-OFF

The IVECO T-WAY offers a choice of permanently engaged PTOs that with the new sandwich PTO deliver up to a maximum of 2,300Nm, which is perfect for a mixer body combined with a concrete pump.

MECHANICAL OR AUTOMATED GEARBOX

The automated gearbox provides greater driving comfort in these vehicles that typically travel short distances and are frequently caught in traffic.

NEW HI-MUX ELECTRONIC ARCHITECTURE

Extensive body builder interfaces and connectivity.

EXCELLENT MANOEUVRABILITY

The offering of axle configurations and wheelbases delivers excellent manoeuvrability and turning circle.

FRONT AND REAR DISC BRAKES

Disc brakes ensure better deceleration and involve lower maintenance costs and wear and tear.

ROBUST CHASSIS

The legendary strength of the chassis, with its 10mm frame with constant section, means that it can carry high-capacity concrete mixers.

KERB WEIGHT OPTIMISATION

up to 500kg – depending on the number of axles, thanks to:

- New one-piece suspension support of suspension system
- EBS and Full Air Disc Brakes
- Alloy wheels option
- Aluminium air tanks option



TIPPER

The IVECO T-WAY will drive wherever you need it to go, carrying big payloads in all conditions – from untarmacked roads to extreme off-road terrains, in all weathers and in the harshest environments.

POWER TAKE-OFF

The body lifting hydraulic circuit is driven by a gearbox or engine PTO that delivers the power needed to operate all types of tipper.

PAYLOAD

With its robust chassis and weight optimisation, the IVECO T-WAY is designed to be equipped with high-capacity tippers and carry big payloads.

WIDE OFFER OF CHASSIS

Choose from a wide offering of wheelbases, ranging from 3,300mm to 5,820mm, and rear overhang lengths.

REAR SUSPENSIONS

The IVECO T-WAY offers a choice of leaf or air suspension in combination with all configurations. Air suspensions maximise comfort and enable you to lower the loading height of the vehicle.

MULTIPLE AXLE CONFIGURATIONS

Choose from a wide variety of configurations to match your exact needs.

CHOICE OF GEARBOXES

Manual or automated; choose your transmission according to the type of road use – maximise comfort and safety while reducing operating costs.

IMPROVED DIRECT AND INDIRECT VISIBILITY

The aerodynamic design of the mirrors and their optimised positioning further improves visibility. The rear window of the AD/AT cabs provides excellent visibility on the rear of the vehicle.

NEW ESP and LDWS

Functionalities for safety improvement.

ENGINES

The line-up offers a choice of engines with two displacements – 9 and 13 litres – to deliver the right power and torque for your mission.

FRONT AXLE

Leaf spring up to 9 tonnes.

COMFORTABLE AND SAFE ACCESS

Well placed handles and footsteps provide safe access to the cab and tipping bridge. The dropdown lowest step is hung with rubber straps to better absorb shocks.

FRONT AND REAR DISC BRAKES ON PWD CONFIGURATION

Disc brakes ensure better deceleration, and involve lower maintenance costs and less wear and tear.



A WIDE VARIETY OF MISSIONS

CRANE & PLATFORM

The IVECO T-WAY can be fitted with every type of crane, from flatbed to platform cranes. The robustness and modular concept of the vehicle enables us to fit cranes at the back of the cab, in a central position or at the rear of the vehicle with no compromise on stability.

TIMBER

The IVECO T-WAY delivers the high power you need and offers the ideal features to load, transport and unload timber with ease. It will transport your logs comfortably in forests and woods, on the roads, and all the way to your destination: our powerful engines, the robust chassis, big payload capacity and hydrostatic drive are all features designed for this multi-faceted mission.

With HI-TRACTION you can rely on all the traction you need to carry a bigger payload. It is lighter than all-wheel-drive and gives you all the grip you need on dirt roads – also after the vehicle has been unloaded. It is also available with the new creep working function that completely disconnects the driveline, enabling you to move the vehicle with hydrostatic power only.

GULLY CLEANER

The IVECO T-WAY is optimised for the easy installation of a gully cleaner body and to provide all the features you need. High performance is essential in this mission, and the new clutch independent sandwich PTO, designed to unleash up to 2,300Nm, delivers the huge torque required.



TIPPER SEMITRAILER

IVECO T-WAY tractors in 6x4 configuration combine the best fuel efficiency with the ultimate safety technologies of the new cab. These features give you the confidence to tackle, with ease, the most difficult conditions on worksites while ensuring high productivity, safety and delivering excellent Total Cost of Ownership.

CONCRETE (PUMPS, MIXER, MIXER PUMPS)

With the IVECO T-WAY you can meet every construction site requirement for concrete – from a simple concrete mixer to pumps and mixer pumps. The introduction of a complete range of PTOs in various positions on the vehicle enables us to meet the needs of every application with torque above 2,000Nm.

PUBLIC UTILITIES

The vast choice of configurations and extreme versatility mean that the IVECO T-WAY range is able to meet the requirements of a wide variety of applications – from road resurfacing to snow clearing, from waste collection to road services.



CHOOSE YOUR CONFIGURATION

The modular, mission-oriented approach of the IVECO T-WAY with a wide choice of features and components, together with the structural strength and low kerb weight, provides ultimate flexibility in customising the vehicle to the specific requirements of a wide variety of applications.

CABS

The IVECO T-WAY cab line-up offers a choice of cabs to match your mission: the **AT** sleeper cab with low or medium roof, and the **AD** short cab with low roof.

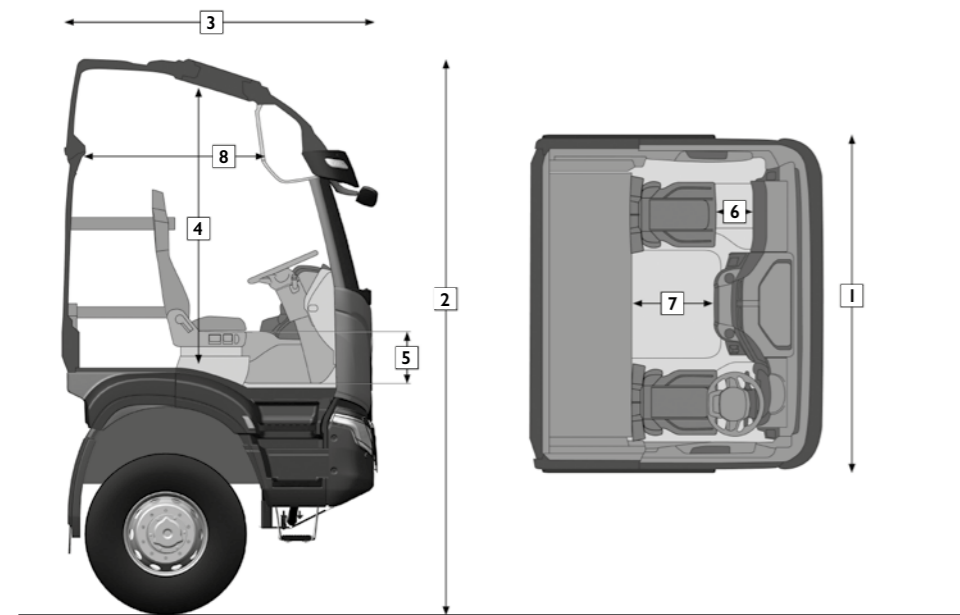

LEGEND

- 1 Width
- 2 Overall Height
- 3 Length
- 4 Floor to Roof Cab Centre
- 5 Tunnel Height
- 6 Passenger Usable Space
- 7 Lower Usable Space
- 8 Upper Usable Space

| | 1 | 2 | 3 | 4 | 5 | 6 | 7 | 8 | | |
|-----------|------------|----------------------|-------------|-------------------------------|--------------------|-----------------------------|-------------------------|-------------------------|---------------------|----------------|
| Roof | Width (mm) | Overall Height (mm) | Length (mm) | Floor to Roof Cab Centre (mm) | Tunnel Height (mm) | Passenger Usable Space (mm) | Lower Usable Space (mm) | Upper Usable Space (mm) | Bunk ⁽²⁾ | Boarding Steps |
| AT | | | | | | | | | | |
| Medium | 2,300 | 3,750 ⁽¹⁾ | 2,150 | 1,850 | 340 | 370 | 470 | 480 | 1 (2) | 3 |
| Low | 2,300 | 3,100 ⁽¹⁾ | 2,150 | 1,250 | 340 | 370 | 470 | – | 1 | |
| AD | | | | | | | | | | |
| Low | 2,300 | 3,100 ⁽¹⁾ | 1,700 | 1,250 | 340 | 370 | – | – | 0 | 3 |

Dimensions can vary according to the model

NOTE

⁽¹⁾ Approximate measures; may change based on suspensions, assembly variables and approximations.

⁽²⁾ Upper bed as option.

AT Cab

Lower bunk length 1,950mm, width 540mm, upper bunk length 1,850mm, width 680mm.

ENGINES

The IVECO T-WAY offers a wide choice of Euro VI diesel engines to suit all applications. The engines, with 2 displacements and power ratings ranging from 340 to 510hp, deliver class leading power.

DIESEL ENGINE LINE-UP

| Engine | DISPLACEMENT (litres) | POWER hp @ rpm | TORQUE hp @ rpm | AFTER TREATMENT SYSTEM | EMISSION STANDARD |
|-----------|-----------------------|---------------------|-----------------------|------------------------|-------------------|
| CURSOR 9 | 8.7 | 340 @ 1,655 - 2,200 | 1,400 @ 1,100 - 1,655 | HI-SCR | Euro VI |
| | | 360 @ 1,530 - 2,200 | 1,650 @ 1,200 - 1,530 | | |
| CURSOR 13 | 12.9 | 410 @ 1,370 - 1,900 | 2,100 @ 900 - 1,370 | | |
| | | 450 @ 1,440 - 1,900 | 2,200 @ 970 - 1,440 | | |
| | | 510 @ 1,560 - 1,900 | 2,300 @ 900 - 1,560 | | |



Cursor 9

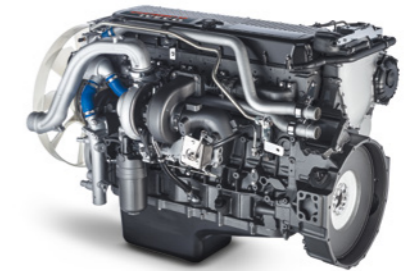

Cursor 13

POWER TAKE OFF

| | DEPENDENT / INDEPENDENT FROM TRANSMISSION | CONNECTION | RATIO | TORQUE (Nm) | ROTATION |
|-----------------------|---|---------------|---------------------------|---------------|-----------------|
| ENGINE PTO | | | | | |
| Switchable | Independent | Pump / Flange | 1.12 / 1.14 | 800 | Opposite engine |
| Not switchable | | | 1.14 / 1.195 | | |
| SANDWICH PTO | | | | | |
| Switchable | Independent | Flange | 1.02 / 1.27 / 1.56 | 1,602 – 2,300 | Same as engine |
| MULTIPOWER PTO | | | | | |
| Switchable | Independent | Flange | 1.29 | 900 | Same as engine |
| Not switchable | | | | | |
| GEARBOX PTO | | | | | |
| NH/1b – NH/1c | Dependent | Pump / Flange | 1.00 | 1,000 | Opposite engine |
| NH/4b – NH/4c | | | 0.90 / 1.28 | 430 | Same as engine |
| NTX/10b – NTX/10c | | | 0.91 / 1.09 / 1.28 / 1.59 | 490 – 720 | |
| N221/10b – N221/10c | | | 1.23 / 1.48 / 1.91 / 2.19 | 470 – 870 | |
| NTX/10c+bR | | | (0.91-1.28) / (1.09-1.59) | 490 – 720 | |



IVECO ON IS THE NEW WORLD OF INTEGRATED SERVICES AND TRANSPORT SOLUTIONS,

created by IVECO to help you make your business more competitive, profitable, sustainable and easier to manage.

It provides a flexible offer that can be customised to match your business requirements and missions: from connected services to boost your vehicle's potential to a complete set of tailored aftermarket solutions to be at your side on every step of your journey!

A CLEAR BENEFIT TO OUR CUSTOMERS

IVECO IS "ON" YOUR SIDE, DELIVERING REAL BENEFITS FOR YOUR BUSINESS WITH THE ADVANTAGES OF THE SERVICE OFFER YOU CHOOSE:



To manage your fleet by monitoring both your vehicles' and drivers' fuel consumption, as well as planning their missions, optimising routes and dispatching orders.



To always keep your vehicle on the road, anticipating and avoiding unforeseen breakdowns. Our roadside assistance will always be with you.



For peace of mind knowing that we will take care of you, your driver and your vehicles while on the road. Specific vehicle monitoring and reporting will leave you free to focus entirely on your work with no worries.



For specialised assistance when you choose from our offer of tailored service contracts.



To complete the IVECO ON offer by choosing original IVECO Parts and Accessories.

SMART PACK

The **SMART PACK**, always included in all IVECO WAY RANGE vehicles, offers the benefits of IVECO ON CARE and IVECO ON UPTIME provided with the following services:

IVECO ON CUSTOMER PORTAL AND APP: Log into the IVECO ON Customer Portal to manage your subscriptions to the available services and EasyWay app permissions.

VEHICLE MONITORING AND REMOTE ASSISTANCE: The remote diagnostics tool, the teleservices and the over-the-air software updates will grant you a proactive approach and maximised vehicle uptime, anticipating possible faults and downtime.

EASY WAY APP: Simplify your life on board: control cabin features and call the Assistance Non-Stop with a simple click. Or ask for Remote Assistance Service during one of your stops. Download the Easy Way App to enjoy the experience in the new cab!

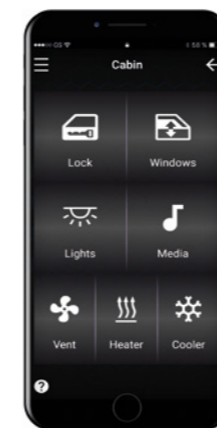

Cabin Control

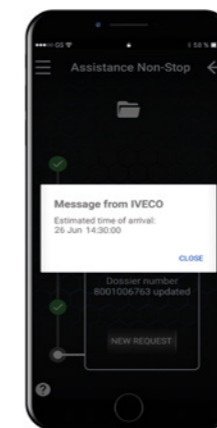

IVECO Assistance Non-Stop

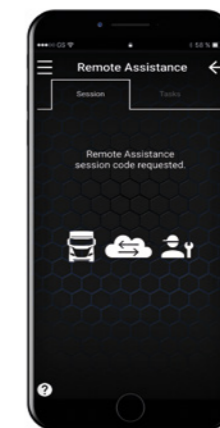

Remote Assistance Service





ELEMENTS





PICK THE SERVICES THAT PERFECTLY MATCH YOUR BUSINESS

The IVECO T-WAY offers an extensive range of services that can be tailored to your precise requirements to keep your vehicle running in top form and your business operating with a healthy bottom line.

The IVECO T-WAY introduces an entirely new level of customisation through connectivity. The real-time vehicle data it provides enables us to offer you **bespoke maintenance plans** based on the real use of your IVECO T-WAY – a perfect match to your business.

Alternatively, our **Elements** range offers the extreme **flexibility** that enables you to choose the combination of Planned Maintenance and Extended Warranty services for your business, and further enrich your package with the Additional Coverage elements.



| | | | | |
|--|--|--|--|--|
| <p>MAINTENANCE </p> <ul style="list-style-type: none"> - Maintenance - Lubrication - Oil and fluid changes according to the repair and maintenance handbook | <p>DRIVE LINE </p> <ul style="list-style-type: none"> - Engine - Fuel injection - Gearbox - Propeller shaft and axle repairs | <p>EXTRA DRIVE LINE </p> <ul style="list-style-type: none"> - Components not already covered by the drive line element e.g. Electrical System | <p>WEAR </p> <ul style="list-style-type: none"> - Clutch - Brake pads - Brake discs - Brake drums - Brake linings for drum brakes | <p>LEGAL INSPECTION </p> <ul style="list-style-type: none"> - Statutory legal requirements for operators licence e.g. Ministry inspection, MOTs |
|--|--|--|--|--|

PREMIUM PACK

The **PREMIUM PACK** offers all the services included in the SMART PACK, plus the full benefits of IVECO ON CARE, UPTIME, FLEET and M&R. It guarantees a follow up on the vehicle information received by putting you in contact with IVECO experts who will advise you on the best way to use it.

You can choose the modular options you wish to add to your package:













IVECO TOP CARE: As a Premium Customer, IVECO provides you with an extra care solution, supporting you to repair your vehicles within 6 hours. Get the priority you deserve.

FLEET MANAGEMENT: It helps you monitoring your vehicles' fuel consumption and drivers, as well as planning their day-to-day activity, optimising routes and dispatching orders. Increase fleet administration capabilities through insights on driver's workdays and geolocation.





IVECO WEB API: The Application Programme Interface allows flexible data integration into the customer's own systems and facilitates the management of IVECO-generated data together with that of other brands' vehicles in a single tool. Available for GPS, vehicle lamp and vehicle faults.

The major "elements" making up the offer (Maintenance, Drive Line, Extra Drive Line, Wear) can be combined in order to create the contract that perfectly suits your business. The table below summarises all the possible combinations:

PLANNED MAINTENANCE CONTRACTS

| | MAINTENANCE  | DRIVE LINE  | EXTRA DRIVE LINE  | WEAR  | LEGAL INSPECTION  |
|--|---|--|--|--|--|
|  3XL • LIFE | • | • | • | • | |
|  2XL • LIFE | • | • | • | | |
|  XL • LIFE | • | • | | • | |
|  L • LIFE | • | • | | | |
|  M • LIFE | • | | | • | |
|  S • LIFE | • | | | | |
|  XS • LIFE | | | | | • |

EXTENDED WARRANTY

| | DRIVE LINE  | EXTRA DRIVE LINE  |
|---|--|--|
|  XTRA XTENDED LIFE | • | • |
|  XTENDED LIFE | • | |

For inclusions / exclusions please refer to contractual documents relevant to your Market.

The truck is much more than a vehicle: it is where thousands of people live and work every day. That's why IVECO Accessories created a range of tailor-made products to meet the driver's needs, improve their performance, enhance the vehicle's style and comfort, and introduce new technologies on board.

CUSTOMISE YOUR IVECO T-WAY TO THE NEEDS OF YOUR BUSINESS

Customise your IVECO T-WAY to match your missions choosing from a wide range of high quality accessories developed to enhance the visibility, comfort, safety and profitability of your vehicle. Details that make the difference.



SAFETY&VISIBILITY

Choose from a range of accessories to increase your safety while driving such as the reversing safety systems providing a greater range of vision during manoeuvres, and beacons which give high visibility in all directions, recommended for emergency situations or special manoeuvres.



PROFITABILITY

To reduce overall TCO IVECO Accessories offer you a wide range of anti-siphon systems. The aluminium devices prevent diesel fuel theft, are indestructible, allow quick refueling and are easy to install.



COMFORT

The IVECO Accessories seat covers and mat lines are perfectly integrated with the internal style of the cab. The choice of materials matches all mission requirements.



HI-TECH ON BOARD

Our accessories aim to make the driver's life on board as productive and comfortable as possible. The coffee machine will help them through long working days. The custom-made dashboard bracket with USB socket will safely hold their mobile device while it is charging.

The IVECO Accessories range is displayed in full in the accessories catalogue – and online at <http://application.cnh-parts-service.eu/iveco.php>



All customisation opportunities at hand with the "IVECO Accessories" free app.

The free app can be downloaded from App Store to get exclusive access to extra images and information.



IVECO Genuine Parts represent the best guarantee of **safeguarding the value of your IVECO T-WAY over time, protecting it from unplanned downtime**, ensuring safety for people and goods. IVECO also offers the widest range of new and remanufactured components, servicing kits and telematics solutions, suitable for every stage of the IVECO T-WAY's lifecycle. IVECO operates a network of 6 parts depots across Europe, covering over 335,000 sqm, managing 400,000 part numbers and guaranteeing 24/7 parts delivery.



IVECO
0080048326000
Assistance Non-Stop



IVECO Assistance Non-Stop responds 24 hours a day, 7 days a week, providing assistance in 36 European countries to help customers keep their vehicles on the road. In case of breakdown it can be reached through a phone call, using the IVECO Non Stop app, or using the telematic system on board.

The IVECO Non-Stop app can also be used to book, in advance, repair work for your vehicle, not just in the event of urgency. You can select the time window and the location and the app will give you a confirmation of the booking.



IVECO CAPITAL

IVECO CAPITAL is the captive financial services brand of IVECO, and offers a full range of financing and leasing for commercial vehicles, including the financing of extended warranty product.*

The finance profiles can be tailored to meet the needs of the customer and apply to new, used and conversions.













For more information, please contact your IVECO dealer.









* Extended warranty can only be included when financed at the same time as the vehicle.











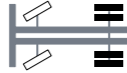
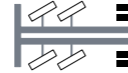







IVECO is a brand of CNH Industrial N.V., a global leader in the capital goods sector that, through its various businesses, designs, produces and sells agricultural and construction equipment, trucks, commercial vehicles, buses and specialty vehicles, in addition to a broad portfolio of powertrain applications. It also distributes high performance genuine parts for all CNH Industrial Commercial Brands.

CHOOSE YOUR IVECO T-WAY MODEL

| IVECO T-WAY | | ARTIC | | | | | |
|------------------------|-----------|---|---|---|---|---|---|
| | | 4x4 AWD | | 6x4 PWD | | 6x6 AWD | |
| | |  | |  | |  | |
| CAB ROOF | AT |  |  |  |  |  |  |
| | AD | - |  | - |  | - |  |
| CHASSIS | | 7.7mm | | | 10mm | | |
| ENGINE / GEARBOX | Cursor 9 | - | | | | | |
| | Cursor 13 | Automated / Pneumatic | | | | | |
| VEHICLE SETUP | | OFF | | | | | |
| REAR AXLE / SUSPENSION | HR | Mechanical / Pneumatic | | | | | |
| CONNECTIVITY BOX | | Standard | | | | | |
| WHEELBASES (mm) | | 3,800 | | 3,300 | | 3,500 | |

| IVECO T-WAY | | RIGID | | | |
|------------------------|-----------|---|---|---|---|
| | | 4x4 AWD | | 6x4x4 PWD | |
| | |  | |  | |
| CAB ROOF | AT |  |  |  |  |
| | AD | - |  | - |  |
| CHASSIS | | 7.7mm | | | |
| ENGINE / GEARBOX | Cursor 9 | Automated / Manual | | - | |
| | Cursor 13 | Automated / Manual | | | |
| VEHICLE SETUP | | OFF | | | |
| REAR AXLE / SUSPENSION | HR | Mechanical / Pneumatic | | Pneumatic | |
| CONNECTIVITY BOX | | Standard | | | |
| WHEELBASES (mm) | | 3,800 - 4,200 - 4,500 | | 3,800 - 4,000 | |

| IVECO T-WAY | | RIGID | | | |
|------------------------|-----------|---|---|---|---|
| | | 6x4 | | 8x4 (2+2) | |
| | |  | |  | |
| CAB ROOF | AT |  |  |  |  |
| | AD | - |  | - |  |
| CHASSIS | | 10mm | | | |
| ENGINE / GEARBOX | Cursor 9 | - | | | |
| | Cursor 13 | Automated / Manual | | | |
| VEHICLE SETUP | | OFF | | | |
| REAR AXLE / SUSPENSION | HR | Mechanical / Pneumatic | | | |
| CONNECTIVITY BOX | | Standard | | | |
| WHEELBASES (mm) | | 3,300 - 3,500 - 3,800 - 4,200 - 4,500 | | 4,250 - 4,500 - 4,750 - 5,020 - 5,820 | |

| IVECO T-WAY | | RIGID | | | | | |
|------------------------|-----------|---|---|---|---|---|---|
| | | 6x6 Light AWD | | 6x6 Heavy AWD | | 8x8 AWD | |
| | |  | |  | |  | |
| CAB ROOF | AT |  |  |  |  | - | - |
| | AD | - |  | - |  | - |  |
| CHASSIS | | 7.7mm | | 10mm | | | |
| ENGINE / GEARBOX | Cursor 9 | Automated / Manual | | - | | | |
| | Cursor 13 | Automated / Manual | | | | | |
| VEHICLE SETUP | | OFF | | | | | |
| REAR AXLE / SUSPENSION | HR | Mechanical / Pneumatic | | | | | |
| CONNECTIVITY BOX | | Standard | | | | | |
| WHEELBASES (mm) | | 3,500 - 3,800 - 4,000 - 4,200 - 4,500 | | | | 4,750 - 5,020 | |



IVECO

Your partner for sustainable transport